

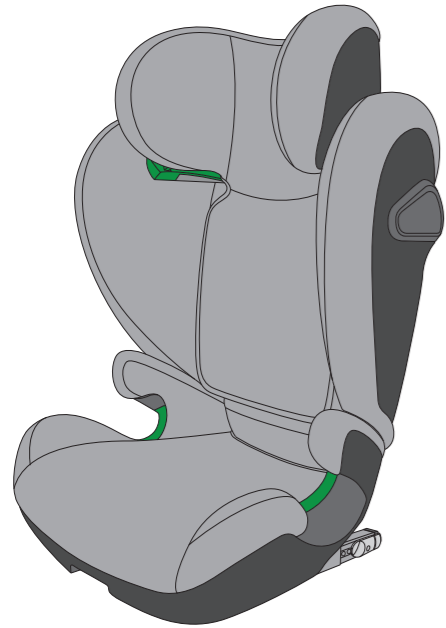

# Sora-Fix USER MANUAL

100cm-150cm  
3-12 years  
UNECE regulation no. R129



GB

5111001 22/07

Made in Germany

## 1 PRODUCT OVERVIEW

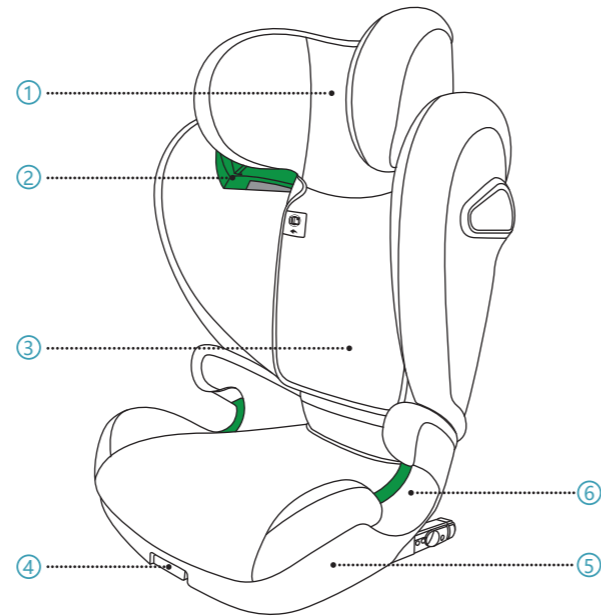

- |                        |                             |
|------------------------|-----------------------------|
| 1. Headrest            | 4. ISOFIX Adjustment Handle |
| 2. Shoulder Belt Guide | 5. Base                     |
| 3. User Manual Pocket  | 6. Lap Belt Guide           |

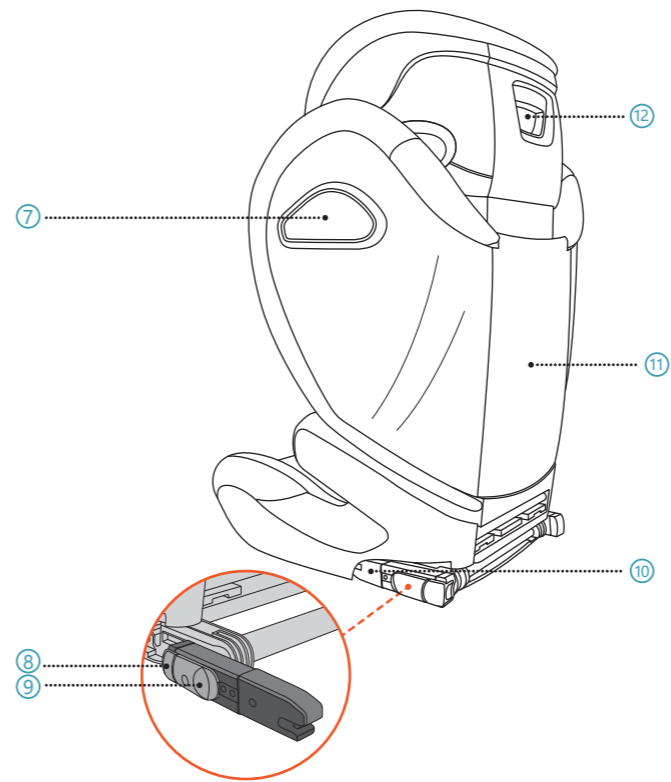

- |                                      |                                |
|--------------------------------------|--------------------------------|
| 7. Integrated Side Impact Protection | 10. ISOFIX Connector           |
| 8. ISOFIX Cap Button                 | 11. Backrest                   |
| 9. ISOFIX Release Button             | 12. Headrest Adjustment Handle |

## 2 INTRODUCTION

Thank you for choosing AVOVA Sora-Fix to ensure your child's safe journey. The seat has been designed, tested and certified according to UNECE R.129, the Enhanced Child Restraint Systems. The seal of approval can be found on the bottom of the seat.

Sora-Fix is approved as a child seat for a child with statures of 100-150 cm, approximately from 3 to 12 years old. It is a Specific Vehicle Booster Seat that fits most but not all vehicles. Please refer to the Vehicle Fitting List.

It is important that you read this user manual BEFORE installing your child seat. Incorrect installation and/or misuse of the seat could endanger your child. Please keep your preferred language version of this user manual in the user manual pocket ③ behind the headrest cover, so users can refer to it any time.

The following symbols are used in this user manual:

**⚠ DANGER** DANGER indicates a hazardous situation which, if not avoided, will result in death or serious injury.

**⚠ WARNING** WARNING indicates a hazardous situation which, if not avoided, could result in death or serious injury.

**⚠ CAUTION** CAUTION indicates a hazardous situation which, if not avoided, could result in minor or moderate injury.

## GENERAL SAFETY INFORMATION

**⚠ DANGER** DO NOT use the child seat for longer than 12 years. Due to aging, the quality of the material may change.

**⚠ DANGER** AVOVA Sora-Fix is shipped in 2 parts in the carton. Please assemble the 2 parts into one Sora-Fix child seat before installing it in the vehicle. The 2 parts must always be assembled into the full child seat and should never be used alone or separately.

**⚠ DANGER** Never secure your child or the child seat with a 2-point belt as that may cause serious injuries or death in the event of an accident.

**⚠ DANGER** Never leave your child unattended in the child seat.

**⚠ DANGER** Please dispose of your seat in the event of any vehicle and/or violent collision as the child seat may be damaged but the damage may not be immediately visible.

**⚠ DANGER** Do not use lubricants on, modify or make any addition to your child seat as this could seriously affect its ability to protect your child.

**⚠ DANGER** The backrest may tip backward when the child seat is at a freestanding position. Always install the child seat on the vehicle seat before having the child sit in it.

**⚠ DANGER** Make sure all passengers are informed about how to release your child in case of emergency.

**⚠ WARNING** AVOVA Sora-Fix is approved for statures of 100-150 cm, in the forward-facing direction of installation.

**⚠ WARNING** When the child is taller than 150 cm or the child's shoulders exceed the highest position of the Shoulder Belt Guide ②, the child must change to a seat which is suitable for a taller child, which could be the vehicle seat.

**⚠ WARNING** AVOVA Sora-Fix can only be used in vehicle seats with ISOFIX Anchoring Points. Please check Vehicle Fitting List for information.

**⚠ WARNING** The seat is compatible with universal seating positions in vehicles. For suitable positions in your vehicle, please read your vehicle handbook.

**⚠ WARNING** The child seat must always be secured when it is in the vehicle by using the ISOFIX Connectors ⑩, even if no child is being transported.

**⚠ WARNING** The child seat needs to be checked regularly to ensure all the parts are functioning correctly and free from any damages.

**⚠ WARNING** Please do not expose the child seat under intensive direct sunlight. Under intensive direct sunlight, the child seat or some of the child seat parts can get very hot which can cause harm to the child.

**⚠ WARNING** Please mind your fingers when operating the child seat.

**⚠ WARNING** Use on the rear seat: Move the front seat forward far enough that the child's feet cannot reach the backrest of the front seat as that is safer.

**⚠ WARNING** The rigid items and plastic parts of the child seat shall be so located and installed that they are not liable, during everyday use of the vehicle, to become trapped by a movable seat or in a door of the vehicle.

**⚠ WARNING** Make sure luggage or other objects are properly secured. Unsecured luggage may cause severe injuries to children and adults in case of accidents.

**⚠ WARNING** AVOVA advises that child seats should not be bought or sold second-hand.

**⚠ WARNING** DO NOT use at home. It's not designed for home use and can only be used in a vehicle.

**⚠ WARNING** If in doubt, consult either the child seat manufacturer or the retailer.

**⚠ CAUTION** The vehicle seats may show signs of wear and tear when using child seat. In order to avoid that, car seat protectors may be used.

**⚠ CAUTION** Do not use any aggressive cleaning products, which may harm the construction material of the child seat.

## 3 ASSEMBLING

**⚠ DANGER** AVOVA Sora-Fix is shipped in 2 parts in the carton. Please assemble the 2 parts into one Sora-Fix child seat before installing it in the vehicle. The 2 parts must always be assembled into a full child seat and should never be used alone or separately.

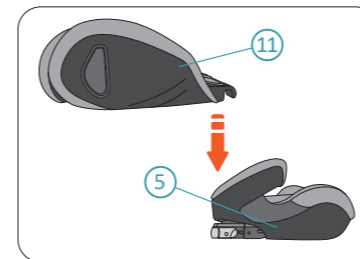

1. Place the Base ⑤ of Sora-Fix on a stable surface. Then take the Backrest ⑪ of Sora-Fix and insert its lower end into the rear side of the Base.



2. Push the Backrest ⑪ upwards until it stands perpendicularly to the Base ⑤ with a click sound.

## 4 INSTALLATION

**⚠ WARNING** Please ensure the vehicle seat that has the child seat installed is in upright position if the vehicle seat is reclinable.

Sora-Fix can be installed forward-facing on vehicle seats approved to UNECE Regulation No.16 or equivalent standards, attached to the vehicle's ISOFIX Anchoring Points ⑬. It is compatible with universal seating positions in vehicles. For suitable positions in a vehicle, please refer to your vehicle handbook.

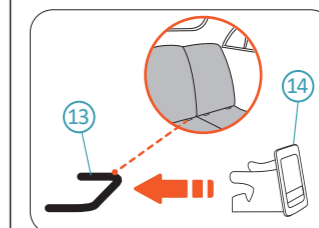

**Optional.** Fit the ISOFIX Insertion Guides ⑭ to the vehicle's ISOFIX Anchoring Points ⑬.

**⚠ CAUTION** Using ISOFIX Insertion Guides to help in the installation of the child seat is optional, but it is recommended. They help to mitigate damages to the vehicle seat. When you want to fold the vehicle seat, remove the ISOFIX Insertion Guides before doing so.

**⚠ CAUTION** For some vehicle models, the vehicle seat may come with built-in ISOFIX guides, so the ISOFIX Insertion Guides could not be used.

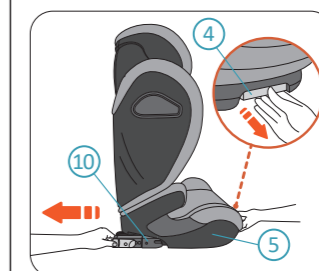

1. Pull and hold the ISOFIX Adjustment Handle ④ with one hand. With the other hand pull the ISOFIX Connectors ⑩ out from the Base ⑤ completely, then release the ISOFIX Adjustment Handle.

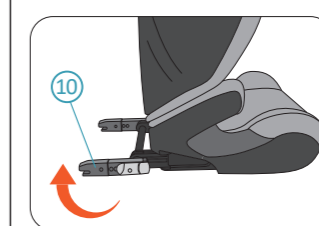

2. Turn the ISOFIX Connectors ⑩ around so the openings face rearward.

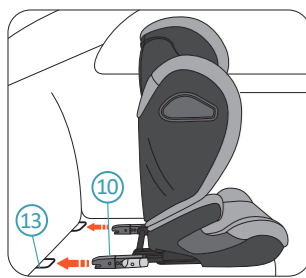

**3.** Aim both ISOFIX Connectors (10) to the ISOFIX Anchoring Points (13) of the vehicle seat. Push the child seat towards the vehicle seat, to engage the ISOFIX Connectors to the ISOFIX Anchoring Points with click sounds.

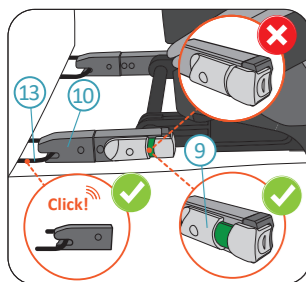

**⚠ DANGER** Green signs must be visible on ISOFIX Release Buttons (9), which indicates that the ISOFIX Connectors (10) are firmly engaged to the ISOFIX Anchoring Points (13). Check both left and right sides.

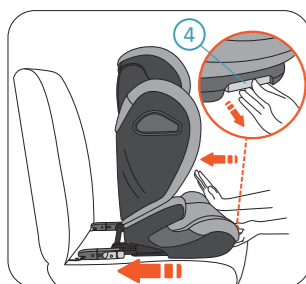

**4.** While pulling and holding the ISOFIX Adjustment Handle (4), push the child seat towards the vehicle seat as far back as possible, until it rests against the vehicle seat backrest firmly.

**⚠ DANGER** After installation, check that all ISOFIX indicators are showing green signs.

**⚠ WARNING** Please check that the child seat is connected to the vehicle securely by trying to pull it out on both sides.

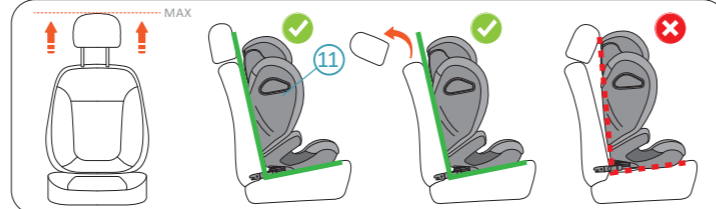

**⚠ WARNING** Make sure the child seat Backrest (11) rests against the vehicle seat backrest firmly, and that the vehicle seat headrest is not pushing the child seat away. You may adjust the vehicle seat headrest to the highest position or even remove the vehicle seat headrest if needed.

## 5 SECURING THE CHILD

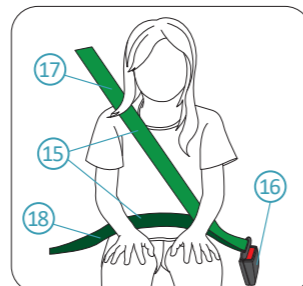

3-point belt (15)  
Buckle (16)  
Shoulder Belt Section (17)  
Lap Belt Section (18)

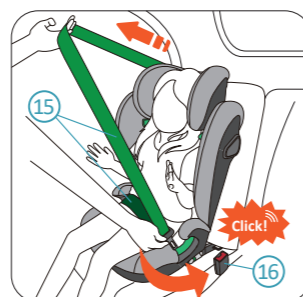

**1.** Seat your child in the child seat. Position the vehicle 3-point belt (15) in front of the child and lock the belt into the buckle (16) of the vehicle with a click.

**⚠ DANGER** Make sure the 3-point belt (15) is not twisted. It should be adjusted to tightly hold the child's body.

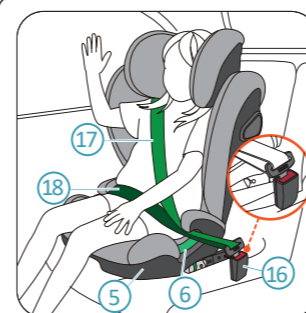

**2.** Place the Shoulder Belt Section (17) and the Lap Belt Section (18) on the side of the buckle (16) into the Lap Belt Guide (6) of the Base (5).



**3.** Place the Lap Belt Section (18) on the other side of the Base (5) into the Lap Belt Guide (6).

**⚠ DANGER** The Lap Belt Section (18) must lie as low as possible over the child's pelvis on both sides to provide the best protection.

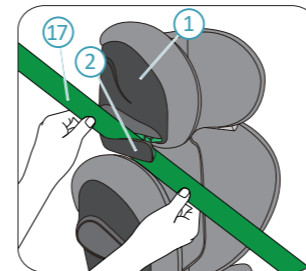

**4.** Route the Shoulder Belt Section (17) into the green Shoulder Belt Guide (2) under the Headrest (1), until it lies completely in the Shoulder Belt Guide (2). Check that the Shoulder Belt Section is not twisted.

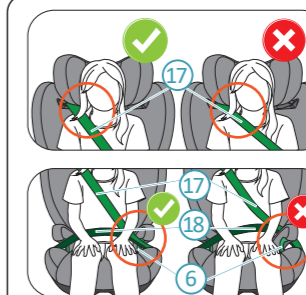
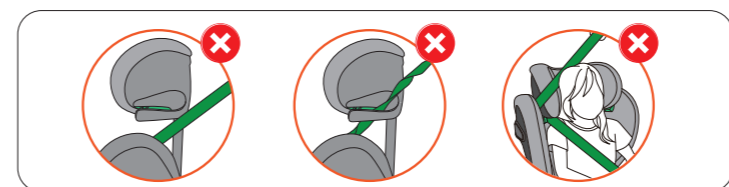

**⚠ DANGER** Check that the Shoulder Belt Section (17) runs over your child's collar-bone, not across the neck.

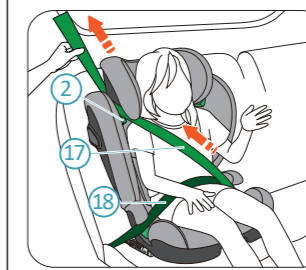

**⚠ DANGER** Check that both of the Shoulder Belt Section (17) and the Lap Belt Section (18) run firmly in the Lap Belt Guide (6).



**5.** Remove the slack of the 3-point belt so it firmly secures the child. First pull the Shoulder Belt Section (17) that crosses the body of the child to remove the slack from the Lap Belt Section (18). Then pull the Shoulder Belt Section (17) above the child seat to remove the remaining slack.



**⚠ DANGER** Never secure your child or the child seat with a 2-point belt as that may cause serious injuries or death in the event of an accident.

**⚠ DANGER** AFTER SECURING YOUR CHILD, CHECK THE BELOW BEFORE TRAVELING:

1. Check that the Lap Belt Section (18) is firmly in the Lap Belt Guides (6) on both sides of the Base (5).
2. Check that the Shoulder Belt Section (17) runs firmly in the Lap Belt Guide (6) on one side and in the Shoulder Belt Guide (2) on the other side.
3. Check that the whole 3-point belt (15) is tight and not twisted. The buckle (16) must not be caught in the Lap Belt Guide (6).

## 6 HEADREST ADJUSTMENT

**⚠ WARNING** The Headrest (1) of the child seat shall be adjusted to a level that the Shoulder Belt Guides (2) are just above the child's shoulders.

**⚠ WARNING** As the child grows, the child seat Headrest (1) shall be adjusted from time to time.

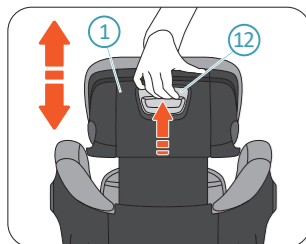

Pull and hold the Headrest Adjustment Handle (12) on the back of the Headrest (1) to release the Headrest. Move the Headrest to the correct height, placing the Shoulder Belt Guides (2) just above the child's shoulders. Then release the handle to lock the height of the Headrest.

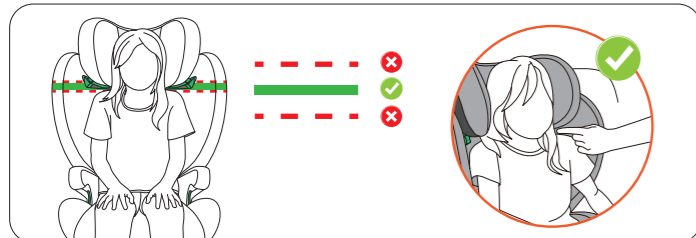

## 7 RELEASING THE CHILD

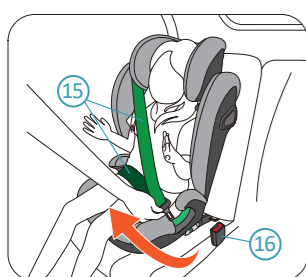

Press the red button on the 3-point belt buckle (16) to unlock the buckle. Pull the 3-point belt (15) from the side of the buckle to the other side, and the child is released.

## 8 REMOVAL

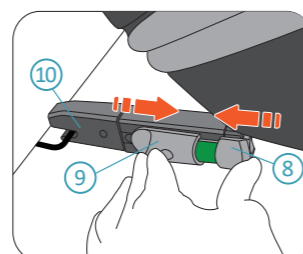

**1.** Press the ISOFIX Cap Button (8) and slide the ISOFIX Release Button (9) to release the ISOFIX Connectors (10), on both sides.



**2.** Turn the ISOFIX Connectors (10) around so the openings face forward towards the Base (5).

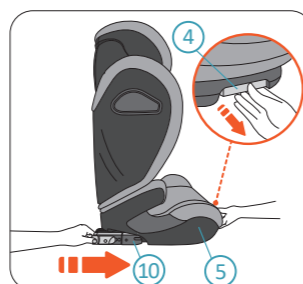

**3.** Pull and hold the ISOFIX Adjustment Handle (4), then push the ISOFIX Connectors (10) into the Base (5).

## 9 CARE AND MAINTENANCE



You may want to remove and wash the child seat's cover from time to time. Please do so with mild detergent in the delicates programme of the washing machine ( $\leq 30^\circ$ ). Please refer to the washing label of the cover. The plastic parts can be cleaned with a mild soap and water.

**⚠ DANGER** The child seat must not be used without the AVOVA seat cover. The cover is a safety feature and may only be replaced by an original AVOVA cover.

### REMOVING AND REFITTING THE SEAT COVER

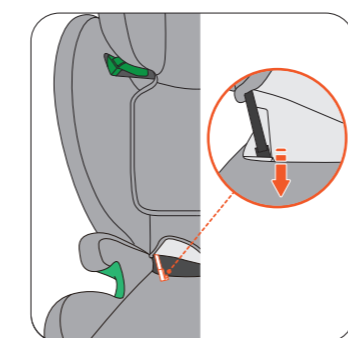
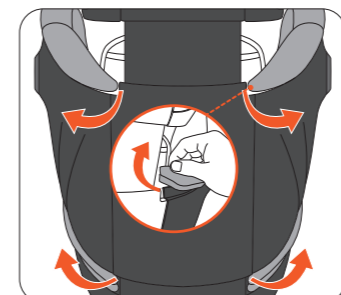
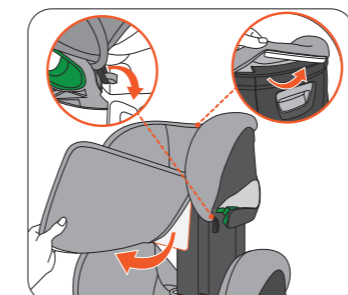

Please refit the cover in the reverse order and direction.

## 10 WARRANTY

**1.** The warranty for AVOVA Sora-Fix lasts for 2 years from the date of original purchase from new. The usage of the product should be in accordance with this user manual. Any damage caused by operations against the instructions in this user manual will void the warranty.

**2.** Never use third parties for maintenance, repair or modification otherwise you will void the warranty. Always check with AVOVA retailers for advice.

**3.** Please keep your proof of purchase properly in case of a warranty claim.

If you have any further questions regarding the child seat's use, please feel free to contact us:

AVOVA GmbH  
Blaubeurer Straße 71  
89077 Ulm  
GermanyT:+49 731 379941-0  
info@avova-childcare.com  
www.avova-childcare.com

## 11 DISPOSAL

When you need to dispose of the child seat, please refer to your local waste disposal regulations. If you have further questions, please contact your communal waste management or administration of your city.